

# Time switches 16 A



Heating and cooling



Shop displays



Lighting for parks



Streetlights and car park lighting



School bells



12  
SERIES



**Mechanical time switches**

- Daily time setting\*
- Weekly time setting\*\*

**Type 12.01**

- Daily
- 1 CO 16 A
- 35.8 mm wide
- 35 mm rail mount

**Type 12.11**

- Daily
- 1 NO 16 A
- 17.5 mm wide
- 35 mm rail mount

**Type 12.31-0000**

- Daily
- 1 CO 16 A
- 72 x 72 mm
- Front panel mount

**Type 12.31-0007**

- Weekly
- 1 CO 16 A
- 72 x 72 mm
- Front panel mount

- Minimum time interval setting:  
1 h (12.31-0007)  
30 min (12.01)  
15 min (12.11 - 12.31-0000)

\* Same program every day

\*\* Different program possible for each of the 7 days of the week

For outline drawing see page 14

**12.01**



- Mechanical daily time switch
- 1 CO 16 A
- 35 mm rail (EN 60715) mount



**12.11**



- Mechanical daily time switch
- 1 NO 16 A
- 35 mm rail (EN 60715) mount

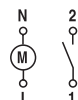

**12.31**



- Mechanical daily or weekly
- 1 CO 16 A
- Front panel mounting

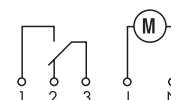

**Contact specification**

Contact configuration		1 CO (SPDT)	1 NO (SPST-NO)	1 CO (SPDT)
Rated current/Maximum peak current	A	16/—	16/30	16/—
Rated voltage/ Maximum switching voltage	V AC	250/—	250/—	250/—
Rated load AC1	VA	4000	4000	4000
Rated load AC15 (230 V AC)	VA	750	420	420
Nominal lamp rating:				
incandescent (230 V) W		2000 (NO contact)	2000	2000
compensated fluorescent (230 V) W		750 (NO contact)	750	750
uncompensated fluorescent (230 V) W		1000 (NO contact)	1000	1000
halogen (230 V) W		2000 (NO contact)	2000	2000
Minimum switching load	mW (V/mA)	1000 (10/10)	1000 (10/10)	1000 (10/10)
Standard contact material		AgSnO <sub>2</sub>	AgSnO <sub>2</sub>	AgCdO

**Supply specification**

Nominal voltage (U <sub>N</sub> )	V AC (50/60 Hz)	230	230	120 - 230
	V DC	—	—	—
Rated power AC/DC	VA (50 Hz)/W	2/—	2/—	2/—
Operating range	AC (50 Hz)	(0.85...1.1)U <sub>N</sub>	(0.85...1.1)U <sub>N</sub>	(0.85...1.1)U <sub>N</sub>
	DC	—	—	—

**Technical data**

Electrical life at rated load in AC1	cycles	50 · 10 <sup>3</sup>	50 · 10 <sup>3</sup>	50 · 10 <sup>3</sup>
Type of time switch		daily	daily	daily   weekly
Switching intervals /day		48	96	96   24 (168/week)
Minimum switching interval	min	30	15	15   60
Accuracy	s/day	1.5	1.5	1.5
Ambient temperature range	°C	-5...+50	-5...+50	-10...+50
Protection category		IP 20	IP 20	IP 20

**Approvals** (according to type)



**Type 12.51**

**Digital (analogue-style) time switch, daily/weekly programming**

- Can be programmed in "Classic" mode via the joystick, or "Smart" mode via smartphones with NFC communication
- Minimum time interval setting - 30 minutes
- Easily configurable for daily or weekly programming

**Type 12.81**

**Digital Astro-switch**

- Can be programmed in "Classic" mode via the joystick, or "Smart" mode via smartphones with NFC communication
- Astro program: calculation of sunrise and sunset times through date, time and location coordinates
- Option for Astro ON period override, by timeswitch
- Location coordinates easily settable for most European countries through post codes
- Offset function: allows programming of switching times offset from the astronomic time (by up to 90 min, in 10 min steps)
- Summer/Winter European, Australian, Brazilian time
- 1 CO 16 A output contact
- LCD status indication, set-up and programming
- Lock with a 4-digit PIN
- Back-light display
- Internal battery for set-up and programming without supply, easily replaceable from the front
- Protective separation between supply and contacts
- 35 mm wide
- 35 mm rail (EN 60715) mount
- Cadmium free contact material

For outline drawing see page 14



- Digital time switch
- 1 CO 16 A

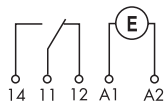

- Digital Astro-switch
- 1 CO 16 A

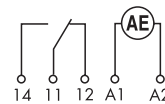

**Contact specification**

Contact configuration		1 CO (SPDT)	1 CO (SPDT)
Rated current/Maximum peak current	A	16/30 (120 A - 5 ms)	16/30 (120 A - 5 ms)
Rated voltage/Maximum switching voltage	V AC	250/400	250/400
Rated load AC1	VA	4000	4000
Rated load AC15 (230 V AC)	VA	750	750
Nominal lamp rating:			
230 V incandescent/halogen W		2000	2000
fluorescent tubes with electronic ballast W		1000	1000
fluorescent tubes with electromagnetic ballast W		750	750
CFL W		400	400
230 V LED W		400	400
LV halogen or LED with electronic ballast W		400	400
LV halogen or LED with electromagnetic ballast W		800	800
Minimum switching load	mW (V/mA)	1000 (10/10)	1000 (10/10)
Standard contact material		AgSnO <sub>2</sub>	AgSnO <sub>2</sub>

**Supply specification**

Nominal voltage (U <sub>N</sub> )	V AC (50/60 Hz)	110...230	110...230
	V DC	110...230	110...230
Rated power AC/DC	VA (50 Hz)/W	2.8/0.9	2.8/0.9
Operating range	V AC (50 Hz)	88...264	88...264
	V DC	88...264	88...264

**Technical data**

Electrical life at rated load in AC1	cycles	100 · 10 <sup>3</sup>	100 · 10 <sup>3</sup>
Switching intervals		48	—
Minimum switching interval	min	30	—
Accuracy	s/day	1	1
Ambient temperature range	°C	-20...+50 (see page 10, diagram L12)	-20...+50 (see page 10, diagram L12)
Protection category		IP 20	IP 20

**Approvals (according to type)**



**Digital time switch, weekly programming**  
- Can be programmed in "Classic" mode via the joystick, or "Smart" mode via smartphones with NFC communication

**Type 12.61**

- 1 CO 16 A

**Type 12.62**

- 2 CO 16 A

- Functions:  
Switch ON, Switch OFF  
Pulse: 1s...59 min
- Minimum time interval setting - 1 minute
- Summer/Winter European, Australian, Brazilian time
- LCD status indication, set-up and programming
- Lock with a 4-digit PIN
- Back-light display
- Internal battery for set-up and programming without supply, easily replaceable from the front
- Protective separation between supply and contacts
- 35 mm wide
- 35 mm rail (EN 60715) mount
- Cadmium free contact material

For outline drawing see page 15

**Contact specification**

Contact configuration		1 CO (SPDT)	2 CO (DPDT)
Rated current/Maximum peak current	A	16/30 (120 A - 5 ms)	16/30 (120 A - 5 ms)
Rated voltage/ Maximum switching voltage	V AC	250/400	250/400
Rated load AC1	VA	4000	4000
Rated load AC15 (230 V AC)	VA	750	750
Nominal lamp rating:			
230 V incandescent/halogen W		2000	2000
fluorescent tubes with electronic ballast W		1000	1000
fluorescent tubes with electromagnetic ballast W		750	750
CFL W		400	400
230 V LED W		400	400
LV halogen or LED with electronic ballast W		400	400
LV halogen or LED with electromagnetic ballast W		800	800
Minimum switching load	mW (V/mA)	1000 (10/10)	1000 (10/10)
Standard contact material		AgSnO <sub>2</sub>	AgSnO <sub>2</sub>

**Supply specification**

Nominal voltage (U <sub>N</sub> )	V AC (50/60 Hz)	12...24	110...230	110...230
	V DC	12...24	110...230	110...230
Rated power AC/DC	VA (50 Hz)/W	2.8/0.9		2.8/0.9
Operating range	V AC (50 Hz)	10...30	88...253	88...253
	V DC	10...30	88...253	88...253

**Technical data**

Electrical life at rated load in AC1	cycles	100 · 10 <sup>3</sup>	100 · 10 <sup>3</sup>
Type of time switch		Weekly	Weekly
Memory locations for switching times		50	50
Minimum internal setting	min	1	1
Accuracy	s/day	1	1
Ambient temperature range	°C	-20...+50 (see page 10, diagram L12)	
Protection category		IP 20	IP 20

**Approvals** (according to type)



- Weekly programming
  - 1 CO 16 A
  - Switch ON, Switch OFF, Pulse
- Weekly programming
  - 2 CO 16 A
  - Switch ON, Switch OFF, Pulse

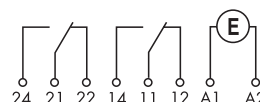
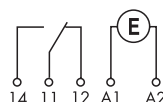

**Weekly Astro time switch**

- Can be programmed in "Classic" mode via the joystick, or "Smart" mode via smartphones with NFC communication
- "Astro" program: calculation of sunrise and sunset times through date, time and location coordinates

**Type 12.A1**  
- 1 CO 16 A

**Type 12.A2**  
- 2 CO 16 A

- Functions:  
"Astro" ON, "Astro" OFF  
Switch ON, Switch OFF  
Pulse: 1s...59 min
- Location coordinates easily settable for most European countries through Post codes
- Offset function: allows programming of switching times offset from the astronomic time (by up to 90 min, in 1 min step)
- Minimum time interval setting - 1 minute
- Summer/Winter European, Australian, Brazilian time
- LCD status indication, set-up and programming
- Lock with a 4-digit PIN
- Back-light display
- Internal battery for set-up and programming without supply, easily replaceable from the front
- Protective separation between supply and contacts
- 35 mm wide
- 35 mm rail (EN 60715) mount
- Cadmium free contact material

For outline drawing see page 15



- Weekly programming
- 1 CO 16 A
- Switch ON, Switch OFF, Pulse

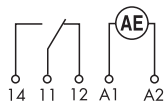

- Weekly programming
- 2 CO 16 A
- Switch ON, Switch OFF, Pulse

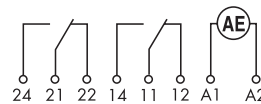

**Contact specification**

Contact configuration		1 CO (SPDT)	2 CO (DPDT)
Rated current/Maximum peak current	A	16/30 (120 A - 5 ms)	16/30 (120 A - 5 ms)
Rated voltage/ Maximum switching voltage	V AC	250/400	250/400
Rated load AC1	VA	4000	4000
Rated load AC15 (230 V AC)	VA	750	750
Nominal lamp rating:			
230 V incandescent/halogen W		2000	2000
fluorescent tubes with electronic ballast W		1000	1000
fluorescent tubes with electromagnetic ballast W		750	750
CFL W		400	400
230 V LED W		400	400
LV halogen or LED with electronic ballast W		400	400
LV halogen or LED with electromagnetic ballast W		800	800
Minimum switching load	mW (V/mA)	1000 (10/10)	1000 (10/10)
Standard contact material		AgSnO <sub>2</sub>	AgSnO <sub>2</sub>

**Supply specification**

Nominal voltage (U <sub>N</sub> )	V AC (50/60 Hz)	110...230	12...24	110...230
	V DC	110...230	12...24	110...230
Rated power AC/DC	VA (50 Hz)/W	2.8/0.9	2.8/0.9	
Operating range	V AC (50 Hz)	88...253	10...30	88...253
	V DC	88...253	10...30	88...253

**Technical data**

Electrical life at rated load in AC1	cycles	100 · 10 <sup>3</sup>	100 · 10 <sup>3</sup>	
Type of time switch		Weekly	Weekly	
Memory locations for switching times		50	50	
Minimum internal setting	min	1	1	
Accuracy	s/day	1	1	
Ambient temperature range	°C	-20...+50 (see page 10, diagram L12)	-20...+50 (see page 10, diagram L12)	
Protection category		IP 20	IP 20	

**Approvals (according to type)**



**Weekly Astro time switch**

- Suitable for applications where a variable light level is required - programmable via smartphone with NFC communications
- Compatible with power supply/ballasts with 0-10V or PWM inputs

**Type 12.A4**

- 1 analog output: 0-10V or PWM
- Functions: "Astro" ON, "Astro" OFF, ON/OFF
- Location coordinates easily settable for most European countries through Post codes
- Offset function: allows programming of switching times offset from the astronomic time (by up to 90 min, in 1 min step)
- Minimum time interval setting - 1 minute
- 50 storable programs
- Summer/Winter European, Australian, Brazilian time
- LCD status indication, set-up and programming
- Lock with a 4-digit PIN
- Back-light display
- Internal battery for set-up and programming without supply, easily replaceable from the front
- Protective separation between supply and contacts
- 35 mm wide
- 35 mm rail (EN 60715) mount
- Cadmium free contact material



- Weekly programming
- 1 analog output: 0-10V or PWM

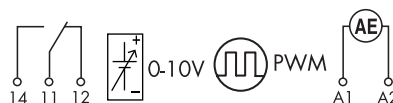

For outline drawing see page 15

**Analogue output characteristics**

Output signal	0-10 V, 10mA max
Output signal	PWM 30 V, 20 mA max

**Contact output characteristics**

Contact configuration	1 CO (SPST)
Rated current/Maximum peak current	A 16/30 (120 A - 5 ms)
Rated voltage/Maximum switching voltage	V AC 250/400
Rated load AC1	VA 4000
Rated load AC15 (230 V AC)	VA 750
Minimum switching load	mW (V/mA) 1000 (10/10)
Standard contact material	AgSnO <sub>2</sub>

**Supply specification**

Nominal voltage (U <sub>N</sub> )	V AC (50/60 Hz)	110...230
	V DC	110...230
Rated power AC/DC	VA (50 Hz)/W	2.8/0.9
Operating range	V AC (50 Hz)	90...264
	V DC	90...264

**Technical data**

Type of time switch	Weekly
Memory locations for switching times	50
Minimum switching interval	min 1
Accuracy	s/day 1
Ambient temperature range	°C -20...+50
Protection category	IP 20

**Approvals** (according to type)



**Electronic digital time switches****- 1 Weekly time setting****Type 12.71**

- 1 CO 16 A
- 17.8 mm wide

- Minimum time interval setting - 1 minute
- Internal battery for set-up without supply
- Pulse output function:  
1 s...59:59(mm:ss)
- Automatic adjustment for daylight saving
- 35 mm rail (EN 60715) mount

**12.71**

- Digital weekly time switch
- 1 CO 16 A
- 17.8 mm wide

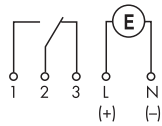

For outline drawing see page 14

**Contact specification**

Contact configuration		1 CO (SPDT)
Rated current/Maximum peak current	A	16/30
Rated voltage/ Maximum switching voltage	V AC	250/—
Rated load AC1	VA	4000
Rated load AC15 (230 V AC)	VA	420
Nominal lamp rating:		
230 V incandescent/halogen W		400
fluorescent tubes with electronic ballast W		100
fluorescent tubes with electromagnetic ballast W		100
CFL W		50
230 V LED W		50
LV halogen or LED with electronic ballast W		50
LV halogen or LED with electromagnetic ballast W		100
Minimum switching load	mW (V/mA)	1000 (10/10)
Standard contact material		AgNi

**Supply specification**

Nominal voltage (U <sub>N</sub> )	V AC (50/60 Hz)	—	230
	V AC/DC	24	—
Rated power AC/DC	VA (50 Hz)/W	1.4/1.4	2/—
Operating range	AC (50 Hz)	(0.9...1.1)U <sub>N</sub>	(0.85...1.1)U <sub>N</sub>
	DC	(0.9...1.1)U <sub>N</sub>	—

**Technical data**

Electrical life at rated load in AC1	cycles	50 · 10 <sup>3</sup>
Type of time switch		weekly
Memory locations for switching times*		30
Minimum switching interval	min	1
Accuracy	s/day	0.5
Ambient temperature range	°C	-30...+55
Protection category		IP 20

**Approvals** (according to type)

\* Switching times in memory may be used more than once i.e. when selected for different days.



## Ordering information

Example: 12 series digital (analogue style) time switch, 1 CO 16 A contact, (110...230)V AC/DC supply

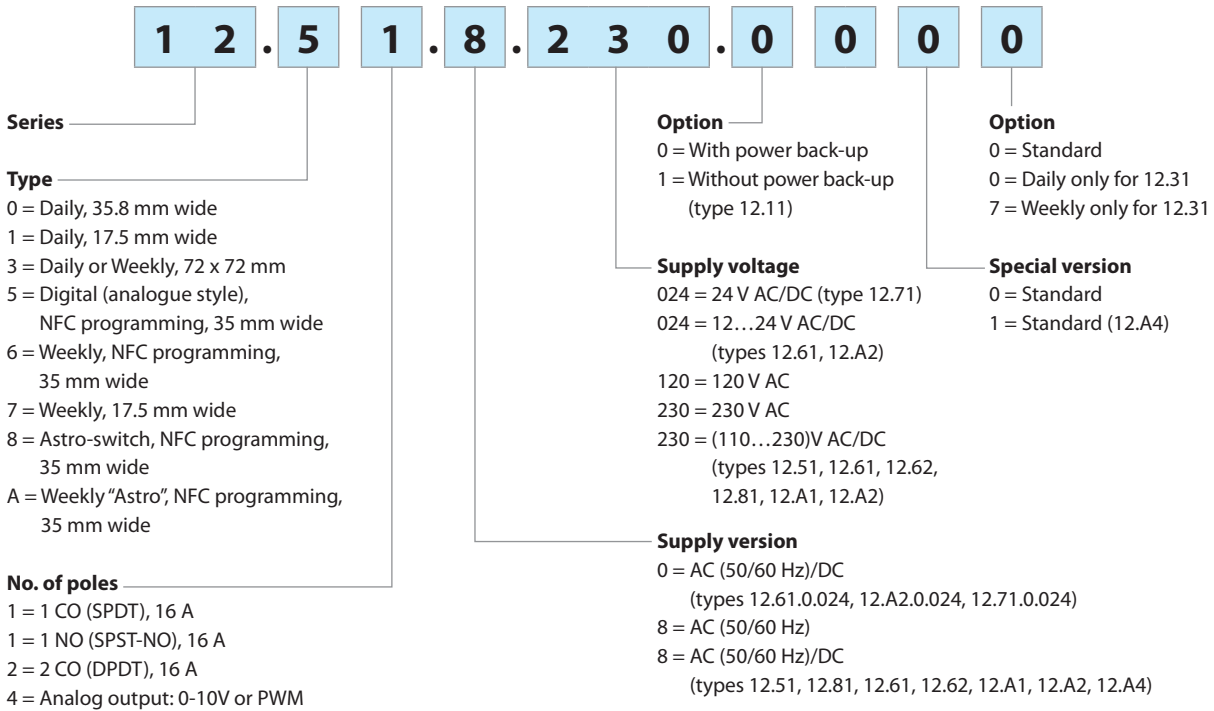

### Codes

12.01.8.230.0000  
 12.11.8.230.0000  
 12.11.8.230.1000  
 12.31.8.230.0000  
 12.31.8.230.0007  
 12.51.8.230.0000  
 12.71.0.024.0000  
 12.71.8.230.0000  
 12.81.8.230.0000  
 12.61.0.024.0000  
 12.61.8.230.0000  
 12.62.8.230.0000  
 12.A1.8.230.0000  
 12.A2.0.024.0000  
 12.A2.8.230.0000  
 12.A4.8.230.0010

## Technical data

Insulation		12.51, 12.61, 12.62, 12.81, 12.A1, 12.A2, 12.A4	12.01, 12.11, 12.31, 12.71		
Dielectric strength between supply and contacts	V AC	4000	4000		
Dielectric strength between open contacts	V AC	1000	1000		
Rated impulse voltage (between supply and contacts)	kV/(1.2/50) $\mu$ s	6	6		
Rated impulse voltage (between open contacts)	kV/(1.2/50) $\mu$ s	1.5	1.5		
EMC specifications					
Type of test		Reference standard			
Electrostatic discharge	contact discharge	EN 61000-4-2	4 kV	6 kV	
	air discharge	EN 61000-4-2	8 kV	8 kV	
Radiated electromagnetic field (80...1000 MHz)		EN 61000-4-3	10 V/m	10 V/m	
Fast transients (burst 5/50 ns, 5 and 100 kHz)		EN 61000-4-4	4 kV	4 kV	
Voltage pulses on supply terminals (surge 1.2/50 $\mu$ s)	common mode	EN 61000-4-5	4 kV	2 kV	
	differential mode	EN 61000-4-5	4 kV	2 kV	
Radiofrequency common mode voltage (0.15...80 MHz)		EN 61000-4-6	10 V	10 V	
Voltage dips	70% $U_N$ , 40% $U_N$	EN 61000-4-11	10 cycles	10 cycles	
Short interruptions		EN 61000-4-11	10 cycles	10 cycles	
Radio frequency conducted emissions	0.15...30 MHz	EN 55014	class B	class B	
Radiated emissions		30...1000 MHz	EN 55014	class B	
Terminals					
 Screw torque	Nm	0.8	1.2		
Max. wire size		mm <sup>2</sup>	AWG	mm <sup>2</sup>	AWG
	solid cable	1 x 6 / 2 x 4	1 x 10 / 2 x 12	1 x 6 / 2 x 4	1 x 10 / 2 x 12
	stranded cable	1 x 4 / 2 x 2.5	1 x 12 / 2 x 14	1 x 6 / 2 x 2.5	1 x 10 / 2 x 14
Wire strip length	mm	9			
Other data					
Power back-up (Battery life)		6 years (12.51, 12.61, 12.62, 12.81, 12.A1, 12.A2, 12.A4, 12.71)			
Battery type		CR 2032, 3 V, 230 mAh (12.51, 12.61, 12.62, 12.81, 12.A1, 12.A2, 12.A4)			
Power back-up		100 h (12.01, 12.11, 12.31 - following 80 h continuous energisation)			
Power lost to the environment		12.51, 12.61, 12.81, 12.A1	12.62, 12.A2, 12.A4	12.01, 12.11, 12.31	12.71
	in stand-by W	0.2	0.2	—	—
	without contact current W	0.9	0.9	1.5	2
	with rated current W	1.5	2.1	2.5	3 (for 1 pole)

### L 12 - Rated current v ambient temperature

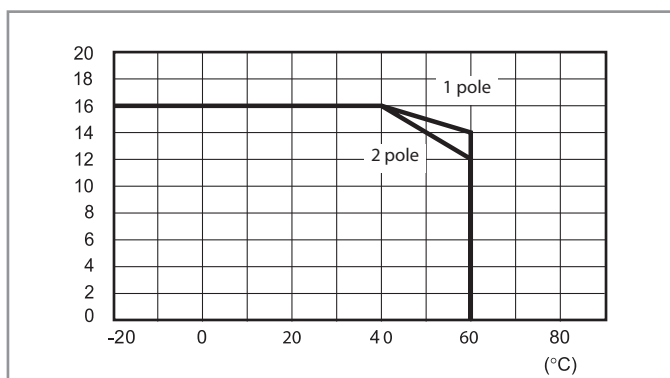

Wiring diagrams

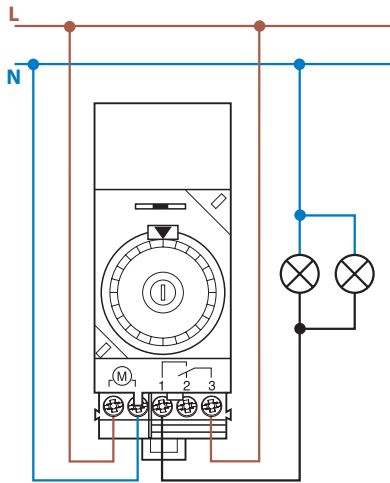

**Type 12.01**

Selector switch:

- ⊖ = Permanently OFF
- AUTO = Automatic
- I = Permanently ON

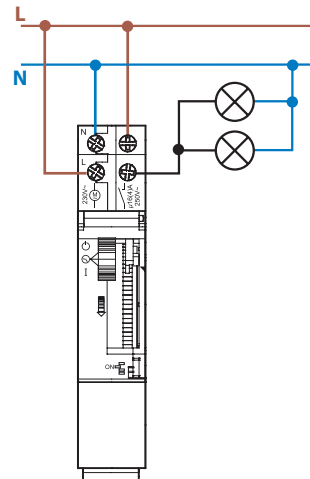

**Type 12.11**

Selector switch:

- ⊖ = Permanently OFF
- ⊖ = Automatic
- I = Permanently ON

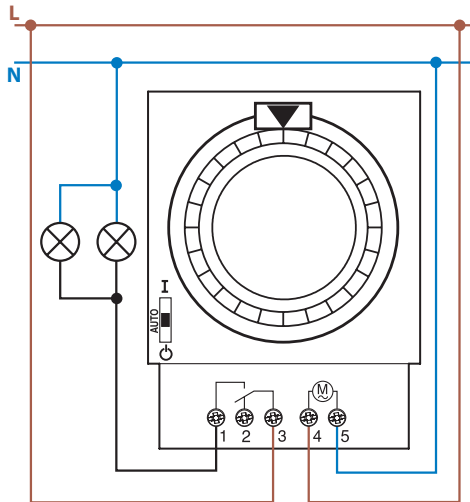

**Type 12.31**

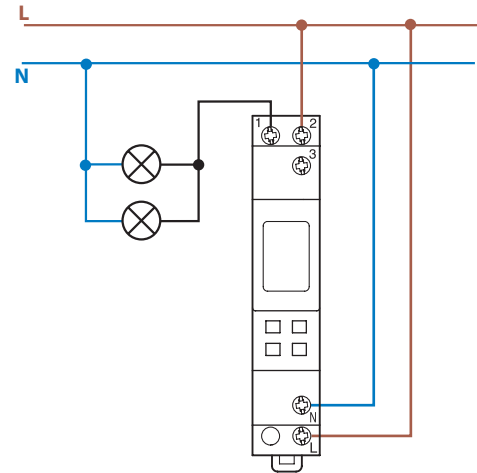

**Type 12.71**

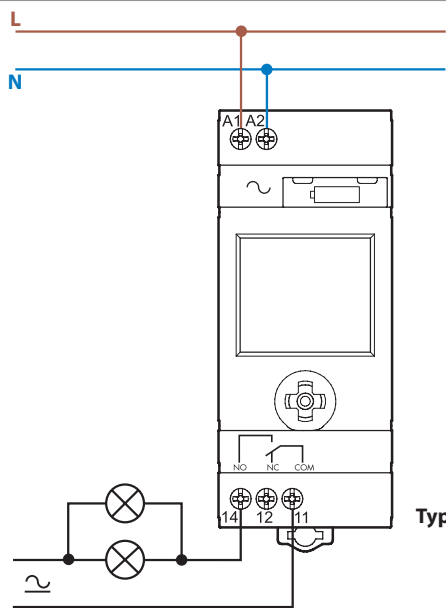

**Types 12.51  
12.81**

Wiring diagrams

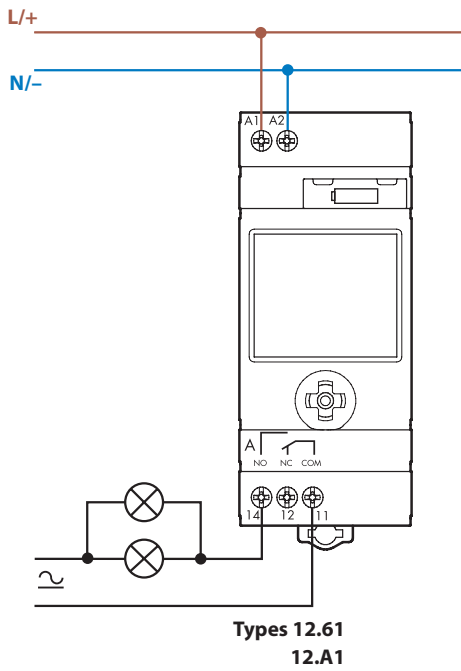

Types 12.61  
12.A1

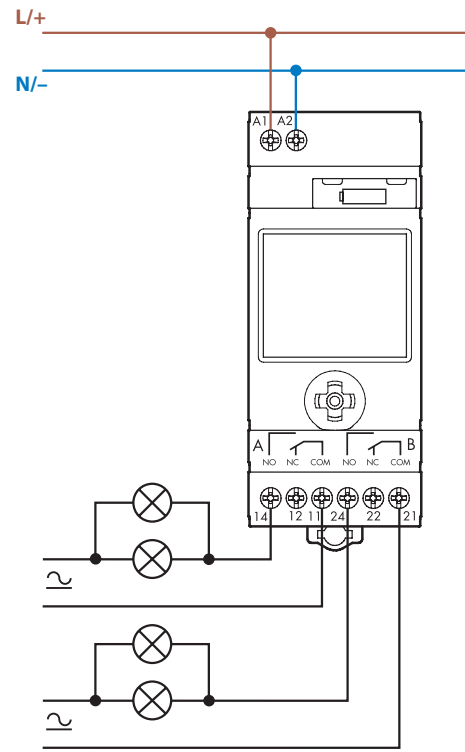

Types 12.62  
12.A2

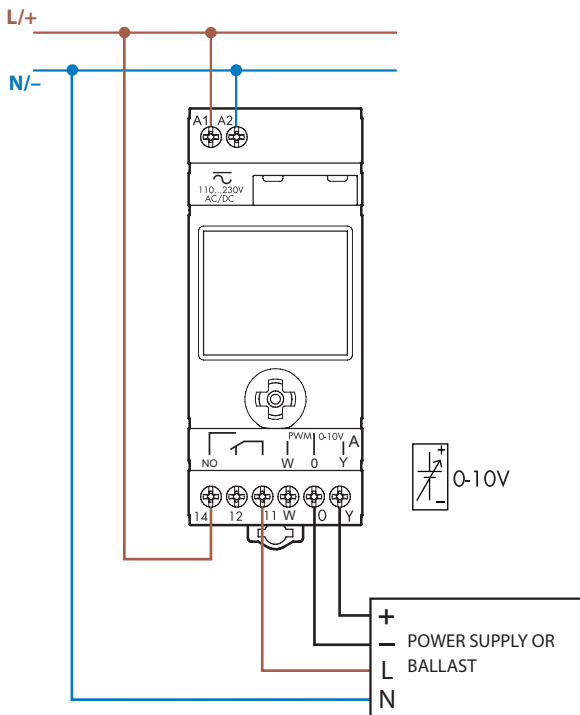

Type 12.A4

NB: All the outputs follow the same programming.

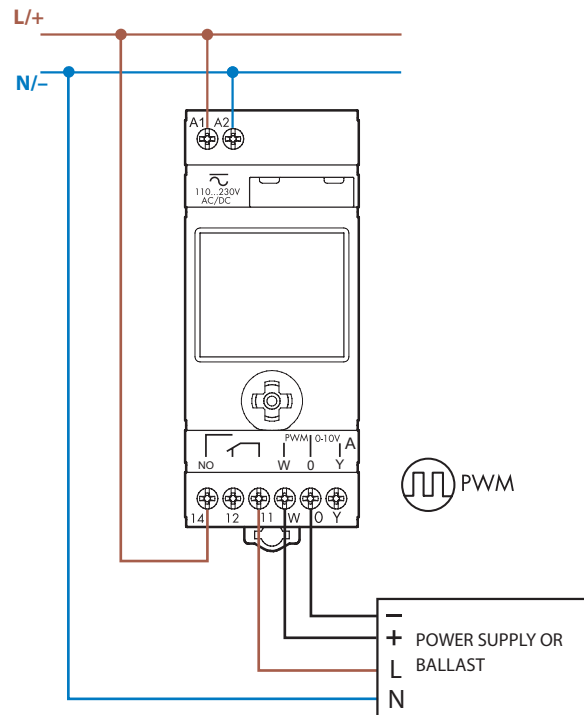

## Two programming modes for type 12.51, 12.61, 12.62, 12.81, 12.A1, 12.A2, 12.A4

### “Smart”

Mode via smartphones with NFC communication using Finder toolbox Android App.



### “Classic”

Mode via the joystick

Android, Google Play and the Google Play logo are trademarks of Google Inc. Apple is a trademark of Apple Inc. App Store is a service mark of Apple Inc.

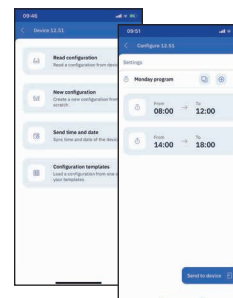
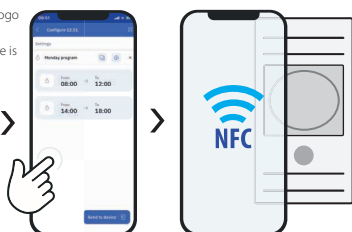

### Finder Toolbox for programming

Once the App FINDER Toolbox is downloaded and installed, you can read an existing program, or program your device with maximum flexibility, changing the smallest details and saving your program directly to your smartphone.

At this point you simply touch the time switch with the smartphone to transfer the data.

### Finder Toolbox for reference

Finder Toolbox provides all technical data sheets and news from Finder.

## Functions type 12.81

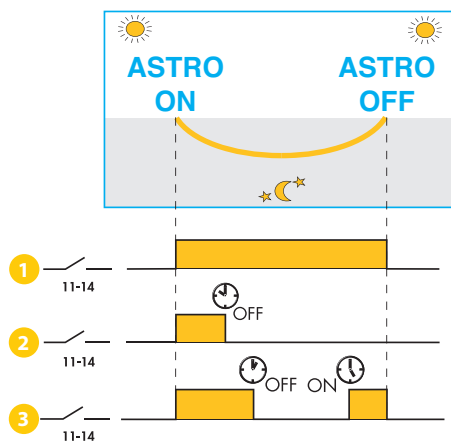

The Override feature permits the 12.81 three different ways of functioning:

- 1 Classic function where the **AstroON** and **AstroOFF** times are determined by the geographic coordinates. These times vary every day.
- 2 Functions such that the output turns on according to the **AstroON** time and turns off according to the clock off-time  $\text{OFF}$ . Application example: shop window lighting on by **AstroON** at sunset and off  $\text{OFF}$  at 00:30.
- 3 Functions such that the output turns on according to the **AstroON** time and turns off according to the clock off-time  $\text{OFF}$ , and then turns back on at the clock on-time  $\text{ON}$  (for the remainder of the ASTRO time period). Application example: company car park lighting, on by **AstroON** at sunset, off end of the evening shift at 23:00  $\text{OFF}$ . On again at the beginning of the morning shift at 5:00  $\text{ON}$  and off automatically by **AstroOFF**\*.

\* Depending on the time of year (summer specifically) it may be that the override ON time will fall after the AstroOFF time. In this case, the output switches off at the AstroOFF time and the override ON time is ignored.

Outline drawings

Type 12.01  
Screw terminal

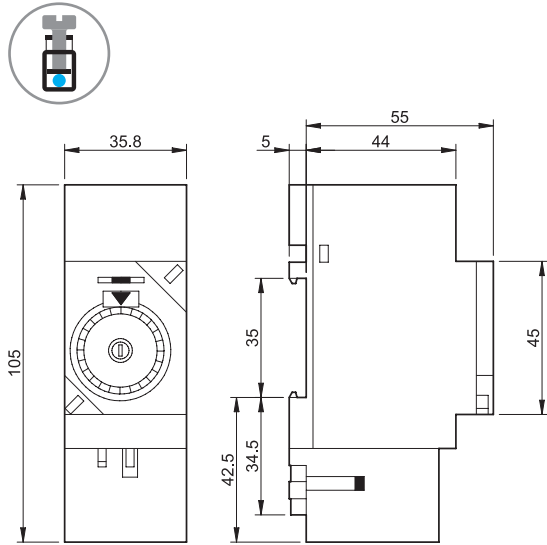

Type 12.11  
Screw terminal

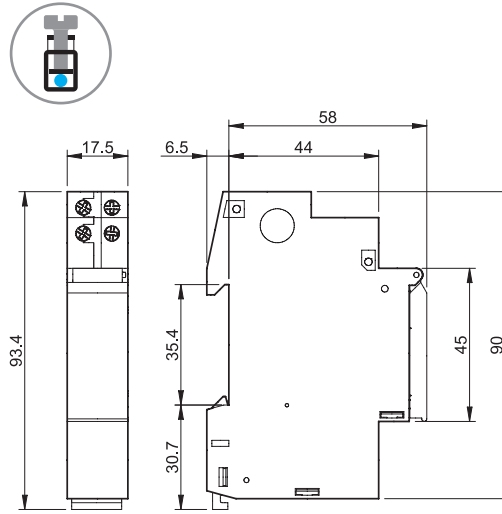

Type 12.31  
Screw terminal

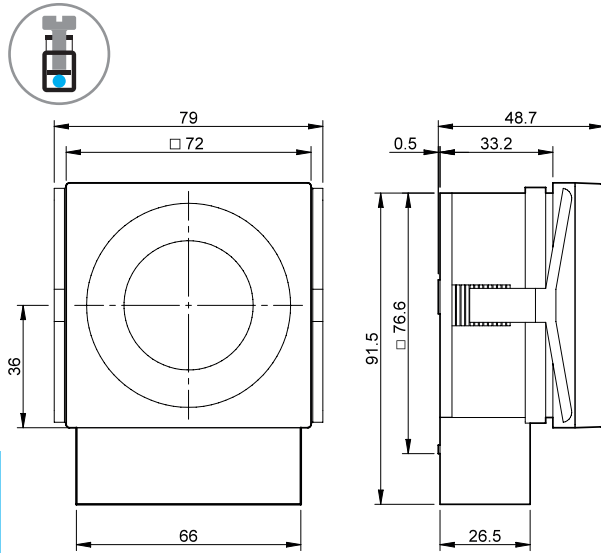

Types 12.51/12.81  
Screw terminal

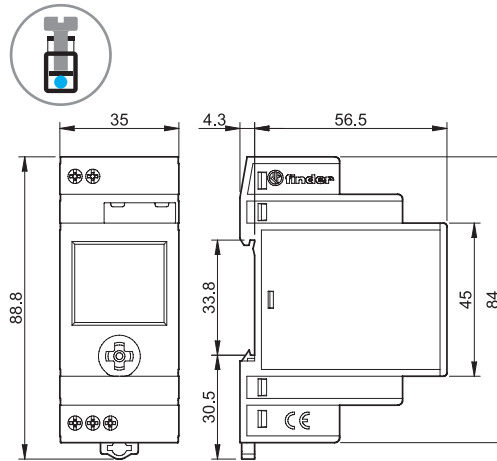

Type 12.71  
Screw terminal

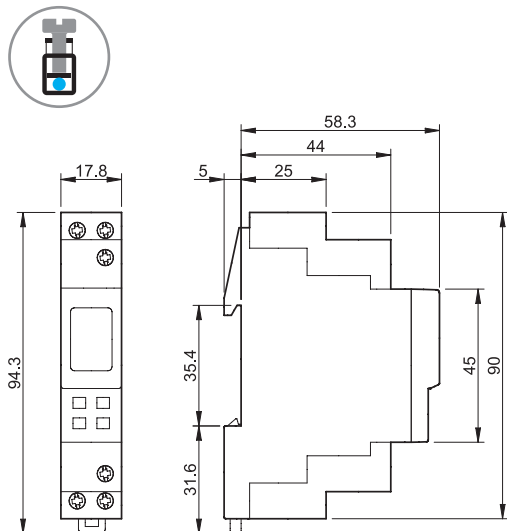

### Outline drawings

Types 12.61 / 12.A1  
Screw terminal

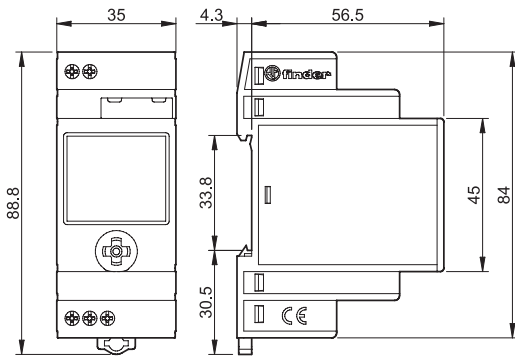

Types 12.62 / 12.A2 / 12.A4  
Screw terminal

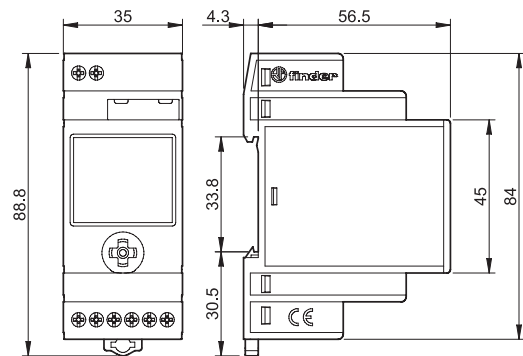

### Battery replacement type 12.51, 12.61, 12.62, 12.81, 12.A1, 12.A2, 12.A4



#### Power-save mode

If the 230 V AC supply is not connected, the time switch enters power-save mode: only the clock is maintained active whilst the display turns off so as to guarantee a long life for the built-in back-up battery. With a press to the joystick it is possible to “awake” the device and enter Display mode (with the “plug” symbol displayed). A further press to will enter the program or set-up mode as explained in the Display mode section above.

After about 1 minute of inactivity the power-save mode will start again. During program or set-up the current absorption is higher than in power-save mode, thus influencing the battery life.

In this mode the display back-light is not active. It is activated following a press to the joystick only with the 230 V AC supply connected, but after about 1 minute of inactivity the display back-light will turn off, and to activate it again it is necessary to press the joystick again.

Note: the output relay only functions if the power supply is connected.

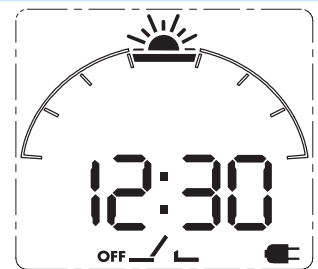

### Accessories type 12.51, 12.61, 12.62, 12.81, 12.A1, 12.A2, 12.A4



011.01

Adaptor for panel mounting, 35 mm wide

011.01

