

Mini Catalogue

This catalogue is only intended for component recognition and can therefore not be used as instruction during construction of CUBIC panels.









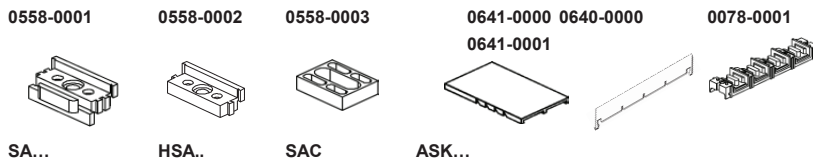
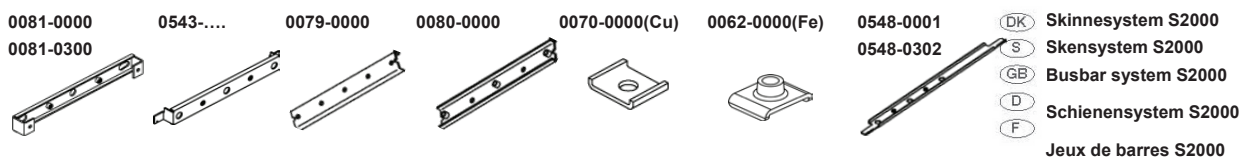
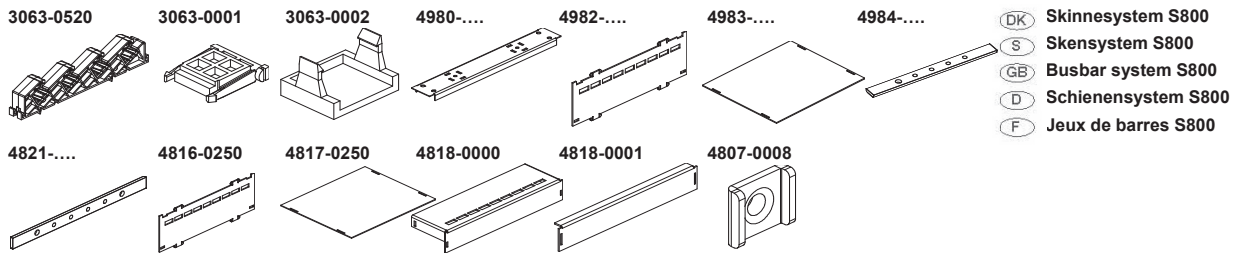
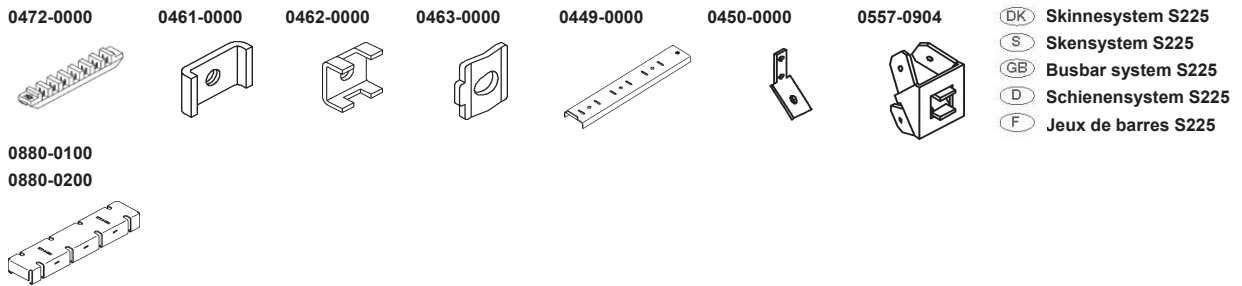
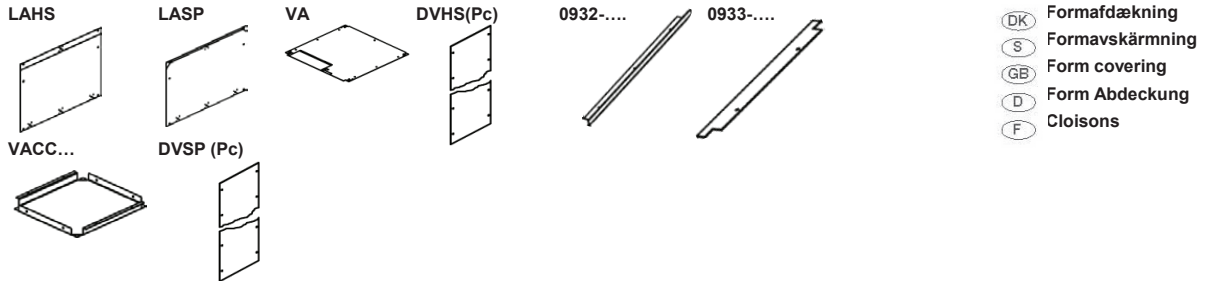
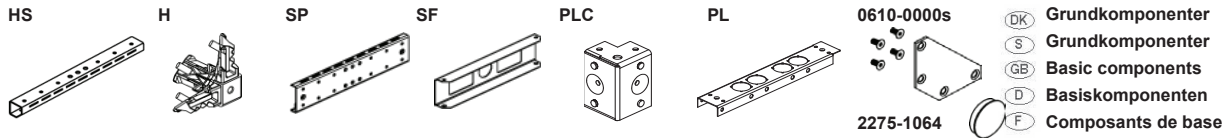







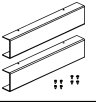
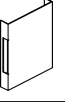

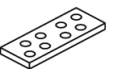
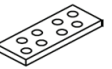
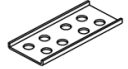
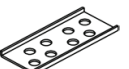





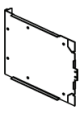
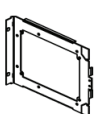

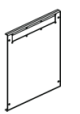
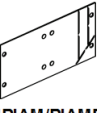
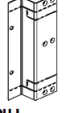
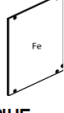
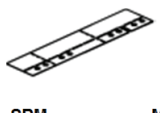
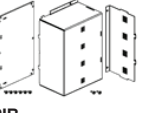
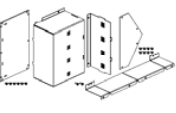

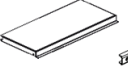
The purpose of the catalogue is to make it easier and thereby quicker to receive a consignment from CUBIC, to unpack it and to sort it.

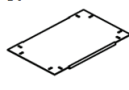
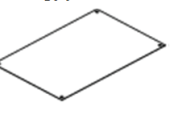
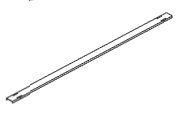
The parts shown in the catalogue are only guiding and can not be used as reference for use or for sizes.

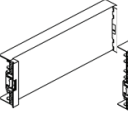
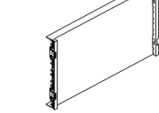
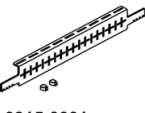
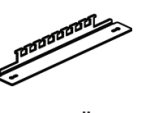
There might be variations of individual components that are not shown here, and for such we refer to CUBIC's main catalogue.

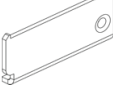
The update of the catalogue follows CUBIC's general policy regarding the same. The updates will be available on CUBIC's partner site.

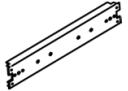

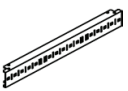
0749-0400b 	0767-0000 	0767-0001 	0767-000. 	1099-0000 	(DK) Skinnesystem S7000 (S) Skensystem S7000 (GB) Busbar system S7000 (D) Schienensystem S7000 (F) Jeux de barres S7000
0745-... 	0748-0100 	0768-0400s 	0768-0500 	0766-... 0772-... 	
0768-0300(Cu) 	0768-0600(Cu) 	0768-0100(Cu) 	0768-0200(Cu) 		
0071-0000(Cu) 0072-0000(Cu) 	0769-0100(Cu) 	0774-0000(Cu) 			
0073-0000(Fe) 0074-0000(Fe) 0766-0000(Cu) 	0769-0200(Fe) 	0773-0000(Cu) 			
MPIS 	MPISO 	MPIMC 	MPIM 	MPIMHC 	(DK) MPI-Indsats (S) MPI, Insats (GB) MPI, Insert (D) MPI, Einsatz (F) MPI, Accessoires pou
LA15MPI 	MPIA 	MPIF 	4419-0000 	MPICB...pcs 	MPICB...s 
MPIAM/PIAME 	MPIH 	MPIHE 	SPM 	MPIB 	
GP 	GPF 	GPM 			(DK) Grundplade (S) Monteringsplåt (GB) Mounting plate (D) Montageplatte (F) Platine de montage
CPx 	CPEx 	060X-0X00 	060X-020X 		(DK) Afdækningsplader (S) Beröringsskydd (GB) Protecting plates (D) Abdeckplatten (F) Plastrons pour appareils modulaires
ID 	AK 	IDS 	ICCP 		(DK) Indsatsjern (S) Insatsjern (GB) Mounting bar (D) Einsatzprofil (F) Traverse de montage
0315-0001 	jk 	0212-... 	0119-... 	BSP 	

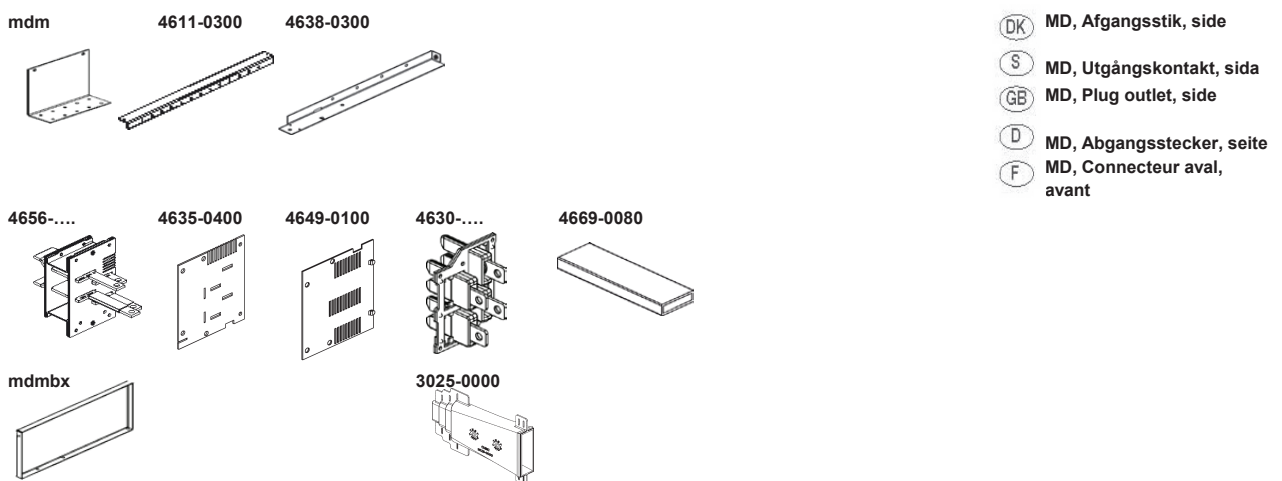
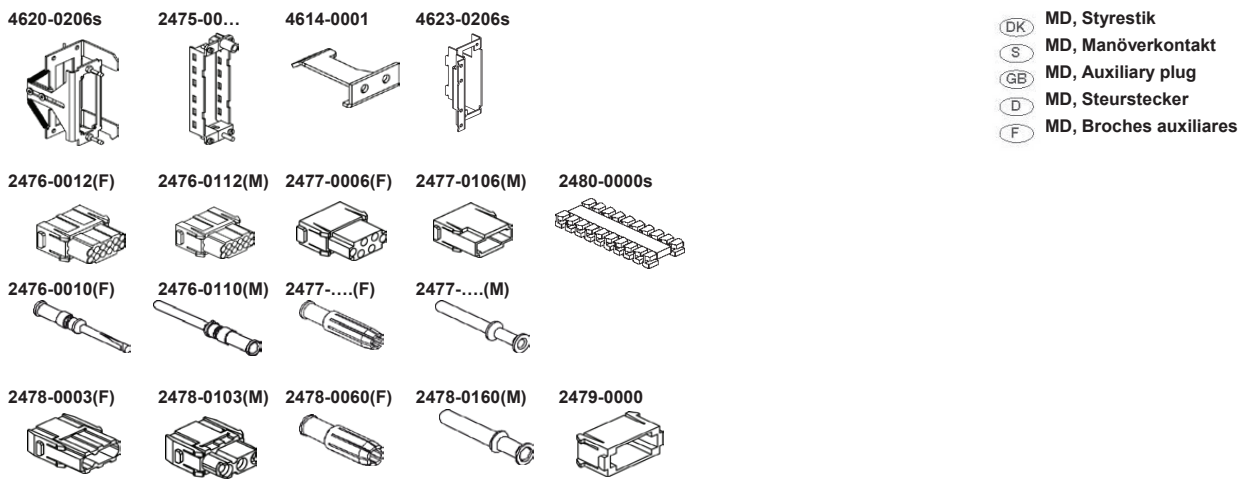
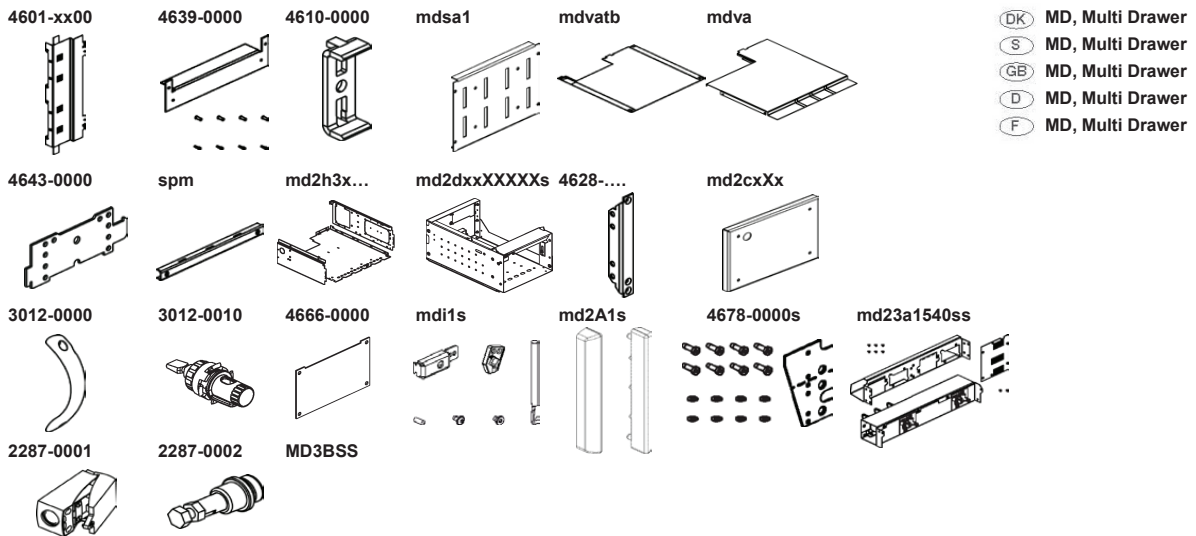

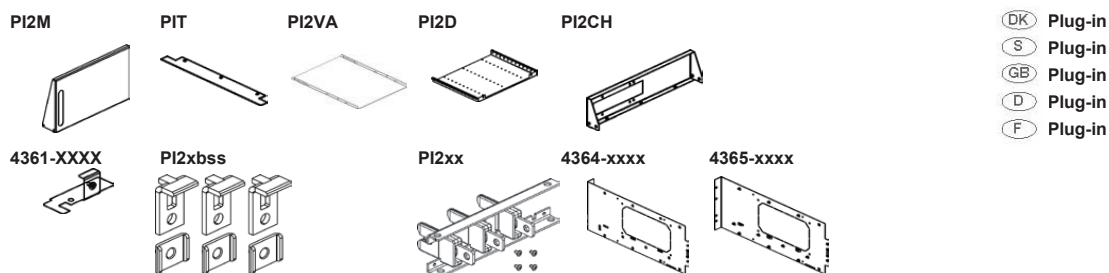

- (DK) Plug-in
- (S) Plug-in
- (GB) Plug-in
- (D) Plug-in
- (F) Plug-in

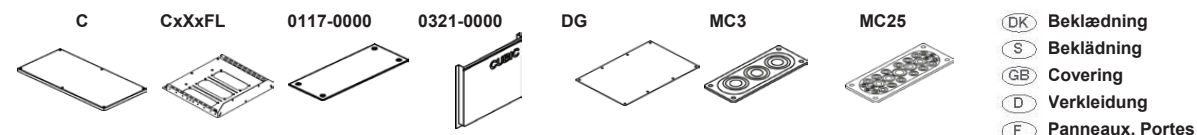

- (DK) Beklædning
- (S) Beklådning
- (GB) Covering
- (D) Verkleidung
- (F) Panneaux, Portes

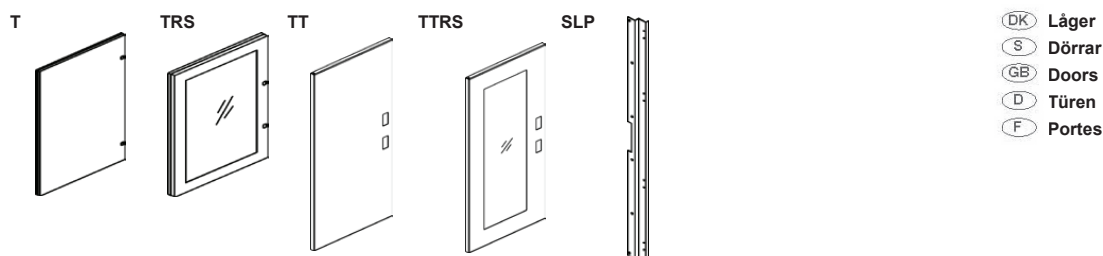

- (DK) Låger
- (S) Dörrar
- (GB) Doors
- (D) Türen
- (F) Portes

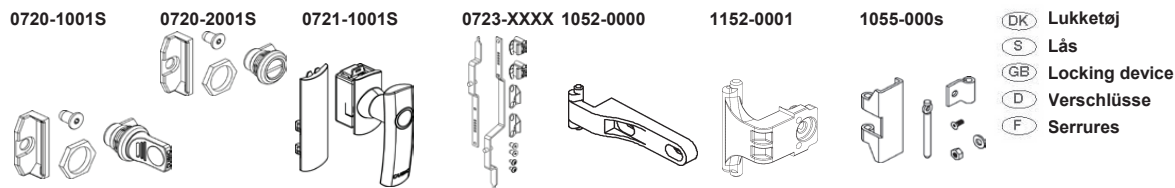

- (DK) Lukketøj
- (S) Lås
- (GB) Locking device
- (D) Verschlüsse
- (F) Serrures



(DK) Skruer og beslag
 (S) Skruvar och beslag
 (GB) Screws and brackets
 (D) Schrauben und Beschläge
 (F) Visserie et Pattes de montage

